

# One Year Unconditional Warranty

---

If for any reason, this ProMaster product fails within ONE YEAR of the date of purchase, return this product to your ProMaster dealer and it will be exchanged for you at no charge. ProMaster products are guaranteed for ONE FULL YEAR against defects in workmanship and materials. If at any time after one year, your ProMaster product fails under normal use, we invite you to return it to ProMaster for evaluation.

WWW.PROMASTER.COM | FAIRFIELD CT 06825

**FOR  
NIKON**

Made in China  
Code 8581



200ST-R [ Nikon  
**Speedlight** ]

*TTL Speedlight for Nikon*

200ST-R SPEEDLIGHT FOR NIKON



# Contents

Precautions	2
Foreword	3
Protection Film	5
Parts Identification	6
LCD Screen Icons	8
Inserting the Batteries	9
Attaching and Detaching	10
Turning On the Power	11
Home Screen and Key Lock	12
Setting Personal functions	13
Utility Menu: Personal Functions	14
TTL: i-TTL Mode	16
M: Manual Mode	17
Repeating Flash Mode	18
Slave Mode F1 (Optical)	19
Slave Mode F2 (Optical)	20
2.4 GHz Slave Mode (Radio)	21
Auto FP high-speed sync HSS	22
Flash value lock (FV lock)	22
Rear-curtain sync	23
Power Zoom Function	24
AF Assist Beam Emitter	25
Bounce Flash Operation	26
Using the Bounce Card	27
Using the Wide Panel	28
Diffusion Dome	29
Color Filters	30
Additional Interfaces	31
Appendix	32
Specifications	33

# Precautions

1. Do not disassemble, open, or repair this speedlight by yourself.
2. Always use batteries of the same type, brand, and age. Always replace all 4 batteries at the same time. Do not combine different types, brands, old, or new batteries. This could cause the batteries to overheat, leak, or explode.
3. This product is not water-resistant. Keep it away from rain, snow, and high humidity areas.
4. Install the batteries in proper orientation as indicated in the battery chamber. Installing the batteries incorrectly could cause them to overheat, leak, or explode.
5. If you change the batteries after a period of sustained continuous firing of the speedlight, the batteries may become warm or hot. This is normal, however you should be careful when handling these batteries.
6. Always switch the speedlight off before changing batteries.
7. Do not fire the speedlight from a short distance directly into the eyes of people or animals. This can cause damage to the retina and may even lead to blindness.
8. Avoid corrosive or flammable substances when cleaning this speedlight.
9. Do not touch the speedlight with wet hands. This could cause an electrical shock.
10. Remove batteries from the unit before storing.

# Foreword

Thank you for purchasing the [pro]master 200ST-R.

The ProMaster 200ST-R speedlight is a high performance, feature-rich unit designed to work with your camera's automatic and advanced functions. It can work as your primary on-camera flash or slave unit in a wireless, multiple flash setup (ProMaster ST1N required as master).

## Here are some of the 200ST-R's features:

### ■ i-TTL Mode

In a Nikon flash system, monitor pre-flashes are fired at all times. The subject is correctly exposed and the overall exposure is less affected by challenging ambient light conditions.

### ■ Manual Mode

By setting the camera's aperture and the speedlight output level, you can manually control exposure. 22 levels of light control are available in manual mode.

### ■ Repeating Flash Mode (RPT)

The 200ST-R fires repeatedly to create stroboscopic multiple-exposure effects in RPT Mode. This is useful when shooting a fast-moving subject for a creative effect.

### ■ FV Lock

Flash Value, or FV, is the amount of flash exposure for a subject. Using FV Lock with a compatible camera, you can lock-in the appropriate flash exposure for the main subject. The flash exposure becomes locked in, even if you change the aperture, composition, or zoom the lens in and out.

### ■ HSS High-Speed Sync

High-Speed flash synchronization at the compatible camera's highest shutter speed is possible. This is useful when you want to use a wider aperture to achieve shallow depth of field to blur the background or create a "stop-motion" effect in your photograph while shooting in conditions with bright ambient light.

## Foreword (continued)

### ■ 2.4G Wireless Slave

The 200ST-R uses a 2.4GHz wireless slave system. It can receive signals from an ST1 (sold separately). You can use up to 3 groups with a wireless range of 325' / 100 meters .

### ■ Flash Exposure Compensation.

Flash output level compensation is performed by modifying the flash output level for the flash illuminated subject.

### ■ Rear-Curtain Sync

Rear-Curtain flash sync. creates a picture in which the blur of a moving subject appears behind the subject and not in front. In this mode, the speedlight fires just before the rear shutter curtain starts to close.

### ■ Bounce Flash

By tilting or rotating the flash head, you can bounce the light off a ceiling or wall to make use of reflected light to create a large, soft illumination.

### ■ Key Lock

The speedlights's control buttons can be locked to prevent them from being pressed accidentally.

### ■ AF-Assist Illuminator

The 200ST-R emits an AF-Assist beam to help the camera properly auto focus in low light situations.

### ■ LCD Panel Backlight

This function sets the LCD panel backlight to on or off.

- Read this instruction manual while also referring to your camera's instruction manual.
- The 200ST-R's features rely on having a compatible camera.

## Protection Film

200ST-R has a protection film over the LCD screen and red lens (front cover). It can protect the LCD screen and front cover from scratches and damage. You may move the protection film or leave it in place if you wish.

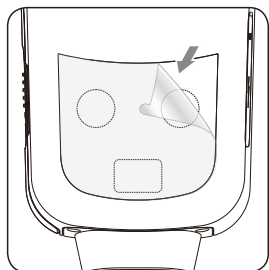

# Parts Identification

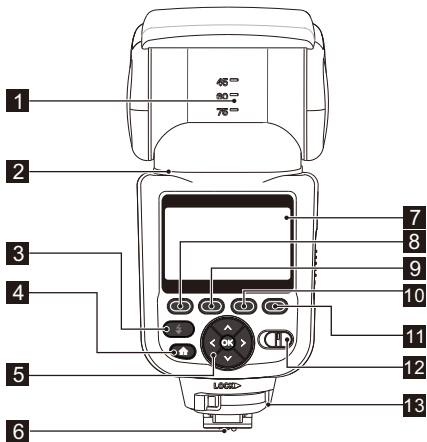

- |  |                                |
|--|--------------------------------|
| <b>1</b> Tilting angle scale                 | <b>7</b> LCD panel             |
| <b>2</b> Rotating angle scale                | <b>8</b> Function button 1     |
| <b>3</b> Test firing button/Ready light      | <b>9</b> Function button 2     |
| <b>4</b> Home button                         | <b>10</b> Function button 3    |
| <b>5</b> Up/Down/Left/<br>Right/OK buttons   | <b>11</b> Function button 4    |
| <b>6</b> Hot foot/<br>Communication contacts | <b>12</b> Power switch(OFF/ON) |
|  | <b>13</b> Locking lever        |

# Parts Identification

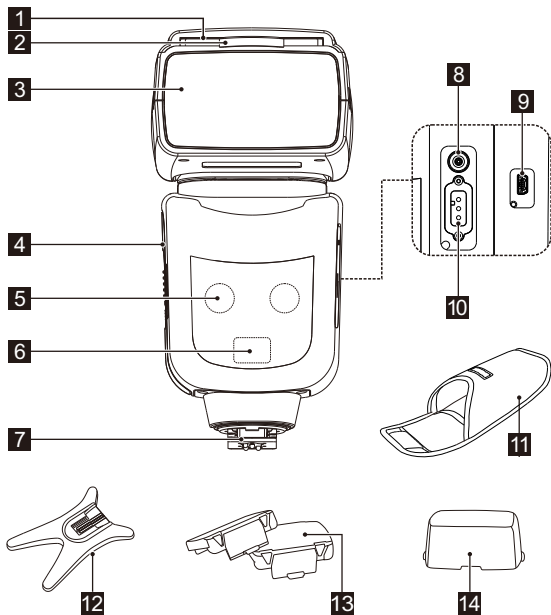

- |   |  |
|---|--|
| <b>1</b> Bounce card                          | <b>8</b> PC sync. terminal                         |
| <b>2</b> Built-in wide panel                  | <b>9</b> USB firmware upgrade port (Mini-B 5-pin)  |
| <b>3</b> Flash head                           | <b>10</b> External power source socket (H.V. port) |
| <b>4</b> Battery door                         | <b>11</b> Protective storage case                  |
| <b>5</b> AF-assist beam emitter (Ready-light) | <b>12</b> Speedlight stand                         |
| <b>6</b> Optical slave                        | <b>13</b> Color filters                            |
| <b>7</b> Locking pin                          | <b>14</b> Speedlight diffuser                      |















# LCD Screen Icons

Shown below are some of the more common icons you will see on the LCD screen of the 200ST-R while using various modes. Additional icons are shown and explained throughout this manual to help you better understand each mode and its features.

\* Note: many of the modes used with these icons are dependent on your camera's capabilities. Refer to its instruction manual.

## Icons

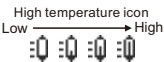
	Front-curtain sync	Controls when the 200ST-R will flash relative to the timing of the camera's shutter. In front-curtain sync, the flash fires when the shutter is first opened. In rear-curtain sync the 200ST-R will fire as the shutter closes. This is particularly important when shooting a subject in motion using a long shutter speed to get a blur.
	Rear-curtain sync	Using rear-curtain sync will show the subject sharp (from the flash illumination) at the end of the blur for a more natural look. For most other types of photography front-curtain sync is advisable.
	High speed sync	Allows the flash to synchronize with your camera set to a very fast shutter speed (up to 1/8,000 second). This is useful when using a large lens aperture to achieve shallow depth of field in bright ambient light conditions where flash illumination is also used.
	Red-eye reduction	Combines red-eye reduction with slow sync. Use for portraits taken against a backdrop of night scenery. Available only in programmed auto and aperture-priority auto exposure modes on some cameras.
	Radio(2.4G) wireless state	Indicates communication with a compatible ProMaster ST1 transceiver in a wireless flash environment.
	Slave icon	This icon simply means the 200ST-R is set to some type of slave mode. This includes 2.4GHz wireless slave mode and the F1 / F2 optical slave modes.
	Standby	Means the speedlight has entered sleep mode to conserve power.
	AF-assist beam emitter on	Allows the 200ST-R's red patterned beam to aid your camera in focusing in dark situations.
	Exposure compensation	Is the amount of light the 200ST-R will emit above or below the average exposure setting.
	Audible alert	Is an icon that will appear so you know the 200ST-R's audible alert system is turned on and is active.
	Batteries low power	Alerts you it is time to replace the batteries.
	Flash firing OFF	Prevents the 200ST-R from firing even though the unit is turned on.
	High temperature icon Low → High	Shows the temperature of the flash head from low to high by the increasing scale inside of this icon.

# Inserting the Batteries

Use any of the following three types of AA battery.

- Alkaline batteries
- Ni-MH batteries
- Lithium-metal batteries

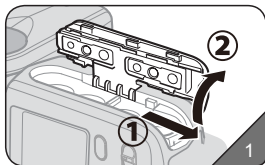

## 1 Open the cover.

Slide the cover in the direction of the arrow and flip it open.

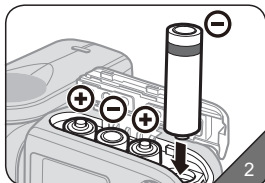

## 2 Install the batteries.

Make sure the + and - battery contacts are properly oriented as shown inside the battery compartment.

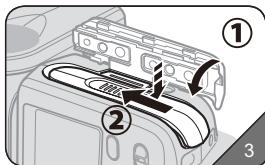

## 3 Close the cover.

Close the battery compartment cover by flipping it down, pressing, and sliding it closed.

- Do not use the Lithium iron phosphate batteries and Carbon zinc batteries.
- If you change the batteries after firing many continuous flashes, be aware that the batteries might be hot.
- Before changing the batteries, be sure to turn off the speedlight.
- When you change the batteries, be sure to use the same type and with full power.
- Remove batteries from the speedlight before storing.

# Attaching and Detaching

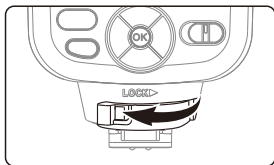

## 1 Prepare to attach the Speedlight.

Slide the locking lever to the left. If the lever is in the locked position (to the right) push its button to release it before sliding left.

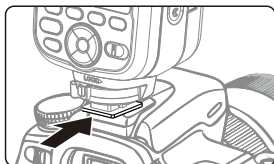

## 2 Attaching the Speedlight.

Mount the Speedlight into the camera's hot shoe all the way.

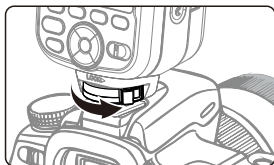

## 3 Securing the Speedlight.

On the mounting foot, slide the locking lever to the right until it locks in place.

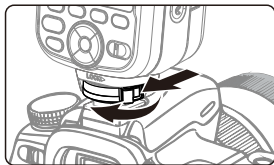

## 4 Detaching the Speedlight.

While pressing the lock-release button, slide the locking lever to the left and detach the speedlight by sliding it out of the camera's shoe.

- Before attaching or detaching the speedlight, be sure to turn off the speedlight.

## Turning On the Power



- Slide the power switch to <ON>.



- The test firing button / ready light will glow red while the 200ST-R is charging. It will turn green when the speedlight is ready to flash.

★ Please note the test firing button requires more pressure to operate than the other buttons on the 200ST-R. This is intentionally designed to prevent accidental firing.

- If the test firing button remains red over 20 seconds, or the low power icon is displayed, please replace the batteries with new ones.
- The 200ST-R will enter sleep/standby mode after 90 seconds of non-use. You can press the test firing button to wake it up. This feature can be disabled in the Utility menu.

# Home Screen and Key Lock

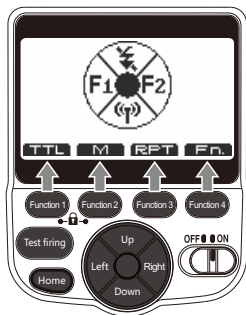

The home screen can be reached by pressing the home button. From here you can change the 200ST-R's mode. Notice the icons on the home screen visually identify which button you should press to access each mode. From the home screen you can quickly access TTL, Manual, Repeat, Custom Functions (Utility menu), Flash OFF, or any of 3 types of wireless slave modes with the press of a button.

## Key Lock



Using the 200ST-R's Key Lock function allows you to prevent accidental changes to the settings. It locks all buttons from functioning except the test firing button.

Press function buttons 1 and 2, between which a lock icon is printed, simultaneously for 2 seconds. The key lock icon [LOCKED] will appear on the LCD and the buttons are locked.

To cancel key lock, press function buttons 1 and 2 again, simultaneously for 2 seconds.

★ The test button is not limited by lock function.



# Setting Personal functions

You can customize the speedlight's features to suit your shooting preferences with Personal Functions. Personal Functions are customizable functions unique to the 200ST-R.

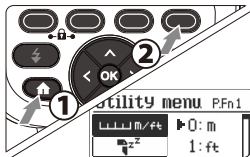
## ■ P.Fn: Personal functions(P.Fn)





### 1 Display the Personal Functions screen (Utility menu).

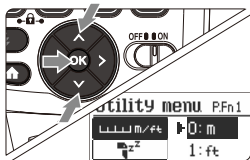



- Press the home button [  ].
  - Press function 4 [  ].
- \* The Utility Menu is displayed.



### 2 Select a Personal Function.

- Press the arrow buttons [  ] / [  ] to select a personal function to set.

### 3 Change the setting.

- Press the [  ] button.
- \* The personal function setting is displayed.
- Press the arrow buttons [  ] / [  ] to change the setting and then press the [  ] button to confirm the change.
  - Press the home button [  ] to exit the Utility Menu.

# Utility Menu

## Personal Functions

NO.	Functional description	
P.Fn1		Distance indicator display
	▶ 0: m	Meters
	1: ft	Feet

NO.	Functional description	
P.Fn2		Auto power off (90 seconds)
	▶ 0: ON	ON/ Enabled
	1: OFF	OFF/ Disabled

NO.	Functional description	
P.Fn3		Slave auto power off timer
	▶ 0: 60 min	60 minutes
	1: 10 min	10 minutes

The 200ST-R will enter standby mode after 60 minutes or 10 minutes of non-use, depending on your setting for P.Fn3. If it is in F1 or F2 slave mode, you will need to press the slave's test button to wake it up. If it is in 2.4GHz slave mode, a test fire from the master ST1 will wake it up.

NO.	Functional description	
P.Fn4		Flash recycle with external power (H.V. port)
	▶ 0:	External & internal power
	1:	External power only

NO.	Functional description	
P.Fn5		TTL Exposure correction
	± 0 Ev	Setting compensation value ±1EV(step 1/6)

Applying a flash exposure compensation amount with this function will affect ALL pictures taken in TTL mode by the set amount. For example, if you enter +1 here and have exposure compensation in TTL mode set to 0, your photos will receive a +1 flash burst in TTL mode. If your exposure compensation in TTL mode is set to +1, all photos will receive a +2 burst. Etc...

NO.	Functional description	
P.Fn6		Flash exposure compensation setting
	▶ 0:	Function 2 and left/right button
	1:	Left/right button only

\*P.Fn6 applies to TTL and M modes. When set to [0] you must press the +/- Fn button before making an exposure compensation change with the left/right arrow buttons. If set to [1] you can simply press the left or right arrow to change the exposure compensation without pressing the +/- Fn button first.

NO.	Functional description	
P.Fn7		Quick flash with continuous shot
	▶ 0: OFF	ON/ Enabled
	1: ON	OFF/ Disabled

P.Fn7 allows the 200ST-R to flash even if it has not fully recycled. This means it can work faster from shot to shot but may not fire at the correct exposure.

NO.	Functional description	
P.Fn8		Temperature monitor
	▶ 0: ON	ON/ Enabled
	1: OFF	OFF/ Disabled

⚠ If you turn off the Temperature monitor, flash recycle time will be extended to prevent overheating and you may shorten the life of the flash tube.

NO.	Functional description	
P.Fn9		AF-assist beam
	▶ 0: ON	ON/ Enabled
	1: OFF	OFF/ Disabled

NO.	Functional description	
P.Fn10		Slave unit recycle state
	▶ 0:	AF flashes & Ready light
	1:	Ready light

With the 200ST-R in slave mode and this function set to [0] the AF light will flash to alert you when the unit is ready to fire. When set to [1] this function is canceled and only the ready light will alert you by glowing green.

## Utility menu setting

▲ → Fn. → ^ / v button →

OK button → ^ / v button →

OK button

# Utility Menu

## Personal Functions

NO.	Functional description	
P.Fn11		Sound monitor (beep)
	▶ 0:ON	ON/ Enabled
	1:OFF	OFF/ Disabled
	Soundmonitor beeps when: Power on / Press buttons / Low power High temperature / Firing	

NO.	Functional description	
P.Fn12		Key (buttons) backlight
	0:ON	ON/ Enabled
	1:OFF	OFF/ Disabled
	▶ 2:12S	On for 12 seconds

NO.	Functional description	
P.Fn13		LCD Display Screen brightness
	0:ON	ON/ Enabled
	1:OFF	OFF/ Disabled
	▶ 2:12S	On for 12 seconds

NO.	Functional description	
P.Fn14		LCD Display Screen brightness
		High(Default)
		Middle
		Low

NO.	Functional description	
P.Fn15	CONTRAST	LCD Display screen contrast
	HIGH	High level
	▶ MID	Middle level
	LOW	Low level

NO.	Functional description	
P.Fn16	RESET	Reset all Personal function settings
	▶ 0:NO	Not reset
	1:YES	Reset
	Press [1] and then the [OK] button and all personal functions will be cleared and returned to factory settings.	

NO.	Functional description	
P.Fn17	VER	Version of firmware
	v x.x	Version
P.Fn17 simply displays the current version of firmware your 200ST-R is using. You cannot change it from this function. You can only view it here.		



When 200ST-R flashes in rapid sequence many times, the Temperature Monitor may be activated.

- ① Temperature monitor enabled: When the icon displays and flashes, the speedlight won't flash.
- ② Temperature monitor disabled: When the icon displays and flashes, the speedlight can fire, but the recycle time will be extended.



# TTL: i-TTL Mode

In this mode information obtained by monitor pre-flashes and exposure control information is integrated by the camera to automatically adjust flash output levels for proper exposure.

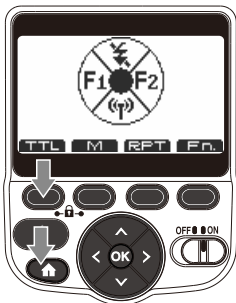

## 1 Enter TTL mode

Press the home button [  ]

Press the [ **Function 1** ] button to set to [ **TTL** ]

## 2 Set the exposure compensation amount

Press the Function 1 button [  ]

Use the arrow buttons [ < ] / [ > ] for adjustment

Press the Function 1 button [  ] to confirm your selection

\* You also can also use the [OK] button or half press the camera's shutter button to confirm your selection

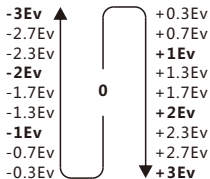

EV compensation scale shown for your reference

- If you prefer to adjust exposure compensation by simply pressing the left/right arrows and without having to press Function button 1 first, you can set this as a personal function for the 200ST-R in its Utility menu. It is P.Fn6.

# M: Manual Mode

In manual mode you can set the flash output from 1/128 power to 1/1 full output in 1/3 steps increments. The 200ST-R will flash at your manually set power level without any TTL, automatic exposure control.

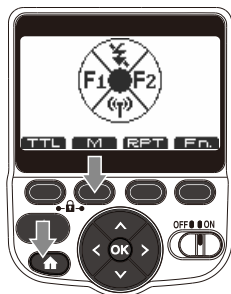

## 1 Enter M mode

Press the home button [ ]

Press the [Function 2] button to set to [ ]

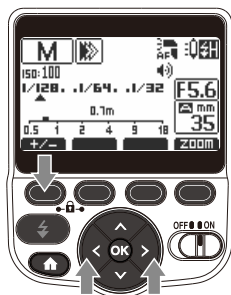

## 2 Set the flash output

Press the Function 1 button [ ]

Use the arrow buttons [ < ] / [ > ] for adjustment

Press the Function 1 button [ ] to confirm your selection

\* You can also use the [OK] button or half press the camera's shutter button to confirm your selection

### Minimum power flash

← 1/128 • • 1/64 • •

1/32 • • 1/16 • • 1/8

1/1 • • 1/2 • • 1/4 • •

Full power flash ←

Manual adjustment scale shown for your reference.  
22 levels of light output control are possible.

# Repeating Flash Mode

In RPT mode, the 200ST-R fires repeatedly during a single exposure, creating stroboscopic multiple-exposure effects. This is useful when shooting fast moving subjects.

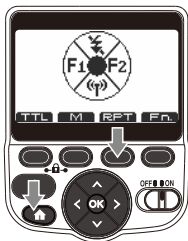

## 1 Enter RPT mode

Press the home button [  ]

Press the [Function 3] button to set to [  ]

## 2 Set the flash output

Press the Function 1 button [  ]

Use the arrow buttons [ < / > ] for adjustment

Press the Function 1 button [  ] to confirm your selection

## 3 Set the number of flashes (times)

Press the Function 2 button [  ]

Use the arrow buttons [ < / > ] for adjustment

Press the Function 2 button [  ] to confirm your selection

## 4 Set the flash firing frequency

Press the Function 3 button [  ]

Use the arrow buttons [ < / > ] for adjustment

Press the Function 3 button [  ] to confirm your selection

\* You can also use the [OK] button or half press the camera's shutter button to confirm your selection.

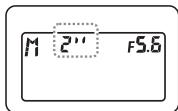
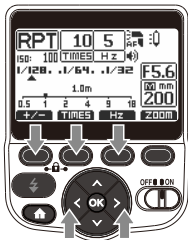

## 5 Set the camera's shutter speed

- Shutter speed = Number of flashes + flash frequency  
For example, if the number of flashes is set to 10 (times) and the flash frequency to 5(Hz), set the shutter speed to 2 sec. or longer.
- "Bulb" mode can also be used for the shutter speed.

- The maximum flash firing number is a function of flash output level and flash firing frequency. See the table in the Appendix for more details. The 200ST-R will not allow you to set an unachievable combination of these settings.
- To avoid overheating and damaging the flash head, do not use RPT flash more than 10 times in succession. After shooting 10 times, allow a rest time of 5-10 minutes to prolong the life of the flash tube.

# Slave Mode F1 (Optical)

The F1 slave mode is used in a manual flash environment. The 200ST-R is triggered optically by another flash (non-radio) by the first burst of light it sees. It will not ignore a pre-flash if one exists from the master.

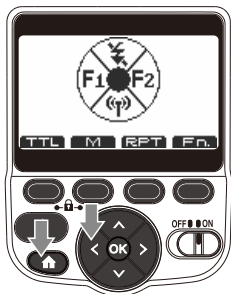

## 1 Enter F1 slave mode

Press the home button [  ]



Press the left arrow button [ < ] to select [ **F1** ] mode

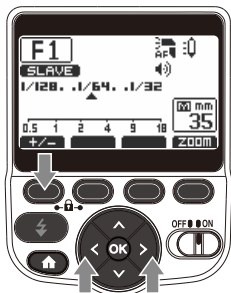

## 2 Set the flash output

Press the Function 1 button [  ]



Use the arrow buttons [ < ] / [ > ] for adjustment



Press the Function 1 button [  ] to confirm your selection

\* You can also use the [OK] button to confirm your selection

- When the 200ST-R is in F1 slave mode, it will fire in-sync. with the master flash. To use this mode correctly, the master speedlight should be set as a manual flash and its TTL flash mode with pre-flash and red-eye reduction modes should not be used so as to avoid firing the 200ST-R slave out of sync. The master should be aimed at the front of the 200ST-R so its optical slave can see the master's flash.

## Slave Mode F2 (Optical)

The F2 slave mode is normally used when the master flash is in TTL mode. F2 slave works as an optical slave and ignores the first burst of light it sees, thereby ignoring the master's pre-flash monitor and firing in-sync. with the master's true flash.

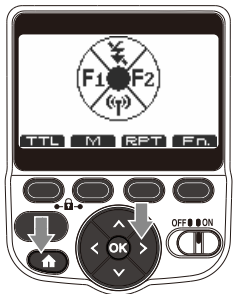

### 1 Enter F2 slave mode

Press the home button [ ]



Press the right arrow button [ ] to select [ **F2** ] mode

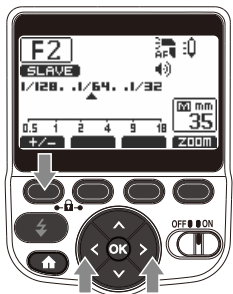

### 2 Set the flash output

Press the Function 1 button [ ]



Use the arrow buttons [ ] / [ ] for adjustment



Press the Function 1 button [ ] to confirm your selection

\* You can also use the [ **OK** ] button to confirm your selection

- When the speedlight is in F2 mode it can support the master speedlight in TTL mode.
- As a basic guide, the effective shooting distance between the master and slave units in F1 or F2 is approx. 10M (33 ft.). The range will vary slightly depending on the ambient light. Don't place any obstacles between the master and slave units (F1/F2).

## 2.4 GHz Slave Mode (Radio)

When set as a radio slave unit, the 200ST-R can receive signals from a ProMaster ST1N transceiver (sold separately) in master mode. The ST1N can control up to 3 groups using one of 30 channels or auto channel for its slave units, reliably, over a long distance (325' / 100m), with optional TTL exposure and other advanced features.

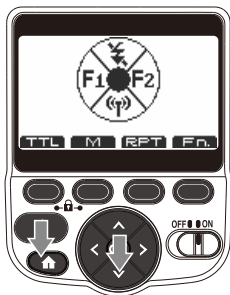



### 1 Enter 2.4 GHz slave mode

Press the home button [  ]

Press the arrow button [  ] to set to [  ]

### 2 Set the channel (CH)

Press the Function 2 button [  ]

Use the arrow buttons [  ] / [  ] for adjustment

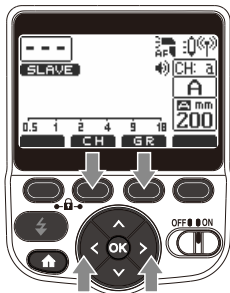

Press the Function 2 button [  ] button to confirm your selection

\* You can also use the [  ] button to confirm your selection. Channel Range: a (auto) + 1-30



### 3 Set the group (GR)

Press the Function 3 button [  ]

Use the arrow buttons [  ] / [  ] for adjustment

Press the Function 3 button [  ] to confirm your selection

\* You can also use the [  ] button to confirm your selection. Group Range: A, B, C

- If another photographer is using the same type and same channel of transmitter nearby, your speedlight may accidentally fire in-sync. with that photographer's transmitter. Please change to a different channel number.
- Be sure the 200ST-R is set to the same channel as the ST1N master.

## Functions to Be Set on the Camera

The following functions are available when used with cameras so equipped. Set these functions on the camera. They cannot be set on the 200ST-R directly.

- For detailed information regarding camera functions and settings, refer to the camera user's manual.

### ■ Auto FP high-speed sync HSS

High-speed flash synchronization at a compatible camera's highest shutter speed is possible.

- Auto FP high-speed sync mode may be automatically set when the shutter speed exceeds the camera's highest 'normal' flash sync speed.
- This is useful in daylight when a wider aperture is required to achieve shallow depth of field to blur the background.
- Auto FP high-speed sync also operates in the 2.4G Wireless System.
- Available flash modes are i-TTL and manual flash.

### ■ Flash value lock (FV lock)

The 200ST-R sets the flash output to a locked flash exposure. This maintains the subject's illumination even if the composition changes.

- The flash exposure level (brightness) remains the same even when the aperture is changed or lens is zoomed in and out.
- Several frames can be shot during FV lock operation.
- FV stands for flash value, meaning flash illuminated subject exposure.

# Functions to Be Set on the Camera

## Rear-curtain sync

In normal flash photography (front curtain sync.), when photographing fast-moving subjects at low shutter speeds, pictures can appear unnatural because the subject frozen by the flash appears behind or within the blurred movement. Rear-curtain sync flash creates a picture in which the blur of a moving subject appears behind the subject and not in front.

- In front-curtain sync. the flash fires immediately after the front curtain is fully open; in rear-curtain sync, the flash fires moments before the rear curtain starts to close.
- Since low shutter speeds are normally used, use of a tripod is recommended to prevent camera shake.
- Rear-curtain sync also operates in the 2.4G Wireless System.
- Rear-curtain sync does not operate in repeating flash mode.



Front-curtain sync



Rear-curtain sync



# Power Zoom Function

The power zoom function automatically adjusts the flash zoom head position to match the lens focal length. Zoom positions can be adjusted between 24mm and 200mm. You can also adjust the flash zoom head position manually.

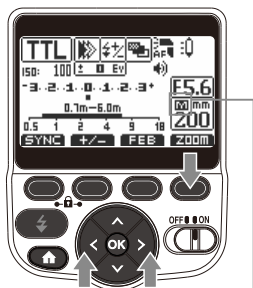

**A = Automatic**

(The flash zooms in sync with camera lens)

**M = Manual zoom**

## The 200ST-R's zoom range scale

24--28--35--50--70--80--  
105--135--200mm

### Set Auto zoom

Press the Function 4 button [ **ZOOM** ]

Press the up/down arrow [ **^** ] / [ **v** ] buttons until **A** is displayed

Press the Function 4 button [ **ZOOM** ] to confirm the **A** setting. Zoom your lens and watch the power zoom match its focal length setting.

\* You can also use the [ **OK** ] button or half press the camera's shutter button to confirm your selection.

### Set Manual zoom

Press the Function 4 button [ **ZOOM** ]

Press the up/down arrow [ **^** ] / [ **v** ] buttons to take the 200ST-R out of **A** mode and into **M** mode. Now press the right/left arrow buttons to manually adjust the power zoom up and down the scale. Notice the equivalent focal length is shown in mm.

Press the Function 4 [ **ZOOM** ] button to confirm the **M** zoom setting.

\* You can also use the [ **OK** ] button or half press the camera's shutter button to confirm your selection.

- If you set the flash zoom manually, make sure it covers the lens focal length so that the picture will not have a dark periphery.
- If you use a PC sync. sync cord to connect your camera to the speedlight's PC terminal, set the flash zoom manually.
- If you use the wide panel, the flash zoom will lock in at 18mm.

# AF Assist Beam Emitter

In low light conditions the AF assist light will automatically emit a red beam pattern towards the subject so the camera can auto-focus.

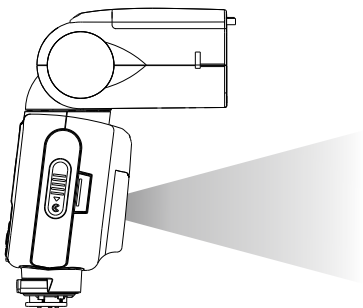

## ■ Turning the AF Assist Beam Off or On

Press the home button [  ]



Press the Fn 4 button to enter the Utility Menu



Use the up/down arrow buttons [  ]/[  ] to display P.Fn9



Press the [ **OK** ] button to enter P.Fn09



Press the up/down arrow buttons [  ]/[  ] to highlight <ON> or <OFF>



Press the [ **OK** ] button to confirm your selection

## Bounce Flash Operation

Tilt or rotate the 200ST-R's flash head to bounce the light off a ceiling or walls, providing more natural-looking pictures of people with softer shadows.

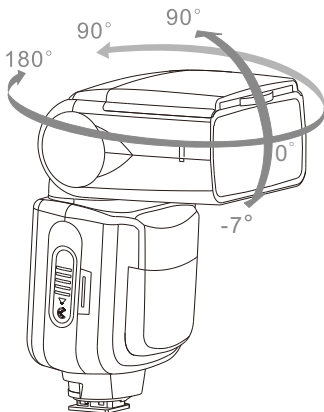

**Vertical angle adjustment:** -7°--0°--45°--60°--75°--90°

**Rotation adjustment:** Left: 0°--30°--60°--90° )  
Right: 0°--30°--60°--90°--120°--135°--180°

- If the wall or ceiling is too far away, the bounced flash might be too weak and can result in under exposure.
- Be sure to select a white/neutral surface to bounce the light off of. Otherwise your pictures will have an unnatural looking color cast similar to that of the reflecting surface.

## Using the Bounce Card

You can use the 200ST-R's built-in bounce card to create a highlight in the subject's eyes, soften the light output, and reduce the chance of red-eye (by creating more distance between the light and the lens).

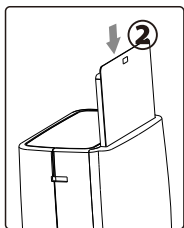
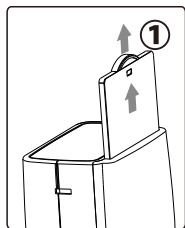

- 1** Pull the round tab. The bounce panel will slide out at the same time as the wide panel.
- 2** Push in only the wide panel leaving the bounce panel exposed.

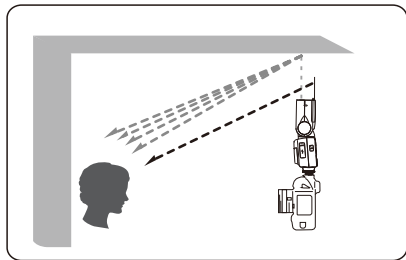

- Direct the flash head forward and straight up by 90°. The bounce card will not work properly if you swing the flash head left or right.
- For maximum effect, stay within 1.5m (4.9ft) of your subject.

- Before pushing in bounce panel, you should slide out the wide panel and push both in together. This is easier and will protect the bounce panel from damage.

## Using the Wide Panel

When the distance between the camera and subject is less than approx. 6 1/2' / 2 m, you can take more natural-looking close-up pictures using the wide panel. The zoom position will automatically set itself to 18mm when the built-in wide panel is used.

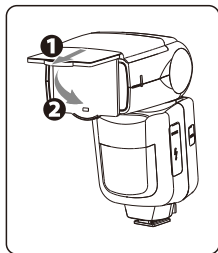

### ❶ Pull out the wide panel.

Slowly pull out the wide panel all the way, and position it over the flash head.

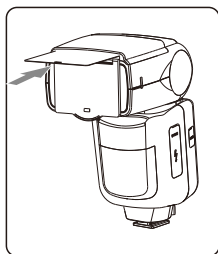

### ❷ Push the bounce card back in.

Push in only the bounce card. Leave the wide panel out.

- The wide panel softens and widens the 200ST-R's light beam to approximately 18mm while reducing the maximum distance the light can travel. Do not use this feature when your subject is far away or the flash may become too weak for proper exposure.

## Diffusion Dome

- By attaching the included ProMaster Diffusion Dome over the flash head, light can be further diffused during bounce flash photography to create extremely soft light with virtually no shadow.
- The same effect can be achieved with the camera in either a horizontal or vertical position so long as the speedlight is oriented properly.
- Light is more effectively diffused when the built-in wide panel is used in addition to the diffusion dome.

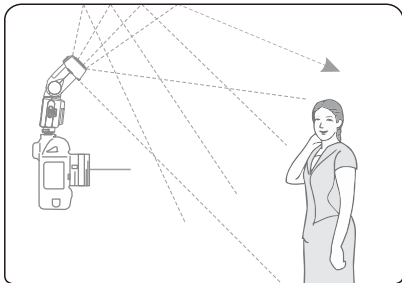

## Attaching the ProMaster Diffusion Dome

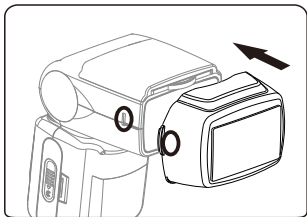

Attach the ProMaster Diffusion Dome as shown in the diagram.

## Color Filters

Color compensation filters (fluorescent filter and an incandescent filter) are included with the 200ST-R for use with flash photography under incandescent/tungsten and fluorescent lighting.

### ■ Using color compensation filters and color filters

Filters	Purpose
Fluorescent filter(Green) included	Balance the color of light from the flash to match that of fluorescent lighting
Fluorescent filter(Orange) included	Balance the color of light from the flash to match that of incandescent or tungsten lighting

### ■ How to attach color compensation filters (included)

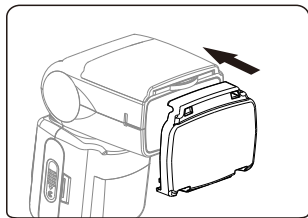

**Place the filter on the flash head and insert into the slit at the top.**

Place the filter as the shown in the diagram.

## Additional Interfaces

The 200ST-R has external connections for use of an external power source (High Voltage battery pack) and PC sync. It also has a USB port for use when upgrading the unit's firmware. This port is compatible with a USB mini-B 5-pin connection.

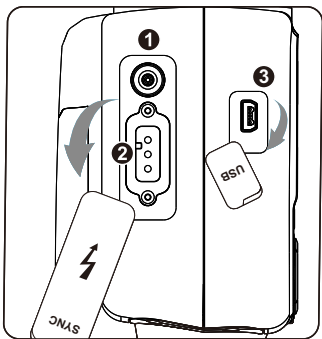

### ① Accessing the external power connector and PC sync.

Pull open the rubber cover on the side of the 200ST-R and rotate it out of the way.

### ② Usage.

1. PC Sync. terminal: The speedlight can fire in-sync. with a camera using this socket and a compatible PC sync. cord.
2. External power connector: The H.V. (high voltage) port provides a stable power supply using an external battery and compatible power cable. You can choose to draw power from only the H.V. port or from the H.V. port + AA batteries with P.Fn4 in the Utility menu.

### ③ USB upgrade port

The 200ST-R has a USB upgrade port. You can update the firmware with a newer version, when available. Refer to [www.promaster.com](http://www.promaster.com)



## Appendix

### Maximum number of flash firings in RPT mode

Frequency	Flash Output					
	M1/4	M1/8	M1/16	M1/32	M1/64	M1/128
1Hz	7	14	30	60	90	100
2Hz	6	14	30	60	90	100
3Hz	5	12	30	60	90	100
4Hz	4	10	20	50	80	100
5Hz	4	8	20	50	80	100
6-7Hz	3	6	20	40	70	90
8-9Hz	3	5	10	30	60	80
10Hz	2	4	8	20	50	70
11Hz	2	4	8	20	40	70
12-14Hz	2	4	8	20	40	60
15-19Hz	2	4	8	18	35	50
20-50Hz	2	4	8	16	30	40
60-199Hz	2	4	8	12	20	40

When the number of the flashes is displayed as "---" (bar display) in the LCD, the maximum number of flashes is as shown in this table.

### Guide No.: (ISO 100, in meters )

Flash Output	Flash Coverage (mm)								
	24	28	35	50	70	85	105	135	200
1/1	26.6	30.5	33.5	37.7	43.0	47.2	50.0	56.3	60.0
1/2	18.8	21.6	23.7	26.7	30.4	33.4	35.4	39.8	42.0
1/4	13.3	15.3	16.8	18.9	21.5	23.6	25.0	28.2	30.0
1/8	9.4	10.8	11.9	13.4	15.2	16.7	17.7	19.9	21.0
1/16	6.7	7.7	8.4	9.5	10.8	11.7	12.5	14.1	15.0
1/32	4.7	5.4	6.0	6.7	7.6	8.4	8.9	10.0	10.5
1/64	3.4	3.9	4.2	4.8	5.4	5.9	6.3	7.1	7.5
1/128	2.4	2.7	3.0	3.4	3.8	4.2	4.5	5.0	5.2

# Specifications

Type	On-camera, i-TTL speedlight
Guide No.	Approximately 60m/200' (at 200mm zoom / ISO100)
Flash coverage	24 to 200mm (18mm when using wide panel ) ● Manual zoom ● Automatic
Bounce angle	90° Up, 7° Down, 90° Left, 180° Right
Flash modes	TTL/M/RPT
Optic slave modes	F1 / F2
Radio wireless slave mode	<ul style="list-style-type: none"><li>● System type: Digital FSK 2.4GHz wireless</li><li>● Distance: 100 m / 325'</li><li>● Channels: Auto + CH 1- 30</li><li>● Groups: 3 groups (A/B/C), up to 15 units in a group.</li></ul>
Display type	LCD display
Button backlight	White
Color temperature	5600K
Flash exposure compensation	3.0 EV to +3.0 EV in increments of 1/3 EV steps
Manual flash	1/128 to 1/1 power (1/3 steps increments)
AF assist beam emitter	Raster pattern
Recycle time	Normal Flash mode : Approx. 0.15~3 seconds with Ni-MH cells Quick Flash mode (P.Fn06): Approx. 0.1~2 seconds with Ni-MH cells
Firmware update	via USB mini-B 5-pin connection
Custom functions	via Personal functions on Utility menu
Standby function	Supports on-camera mode (auto standby after 90 sec. non use)
Repeating Flash	1-100Hz
Flash duration range	1/800~1/20,000 sec.
Camera's sync modes	Front-curtain sync, Rear-curtain sync, and HSS high-speed sync. up to 1/8000 second
FV lock	Support
External power	Support via H.V. port
PC terminal	Support
Dimensions	Approx. 7 3/4" x 3 1/16" x 2 5/16" / 196.8 mm x 77.8 mm x 58.7 mm
Weight	Approx. 15 oz / 425 g (speedlight only)



[pro]master®

ST1

*Wireless*

# *Transceiver*

*For Nikon (ST1N)*

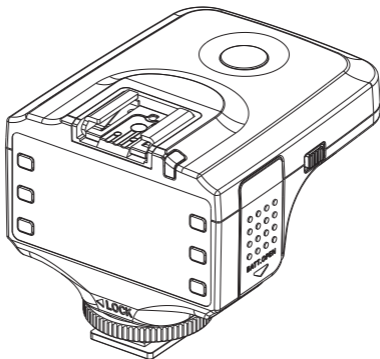



# Contents

---

Precautions .....	2
Forward .....	3
Parts Identification .....	5
<b>Basic Operation</b> .....	9
Transmitter operation .....	13
Receiver operation .....	16
<b>Flash triggering</b>	
Parameter control triggering mode .....	18
Non-parameter control triggering mode .....	19
<b>Advanced Applications</b>	
Shutter release function .....	20
Firmware upgrade .....	21
Troubleshooting Guide .....	22
Specifications .....	24

# Precautions

1. Do not attempt to disassemble, open, or repair this transceiver by yourself.
2. Always use batteries of the same type, brand, and age. Always replace both batteries at the same time. Do not combine different types, brands, old, or new batteries. This could cause the batteries to overheat, leak, or explode.
3. This product is not water resistant. Keep it away from rain, snow, and high humidity areas.
4. Install the batteries in proper orientation as indicated in the battery chamber.
5. Remove any batteries from the unit before storing for long periods.

**This product is a wireless transceiver, meaning it can act as either a transmitter or as a receiver. For the purpose of this instruction manual it will be called a transmitter (master unit) when installed on the hot shoe of a camera. It will be called a receiver (slave unit) when a flash is installed or connected to it for remote operation. Also, the words 'flash' and 'speedlight' may be used interchangeably**

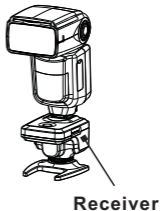
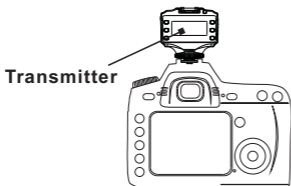

---

## Foreword

---

Thank you for purchasing the **[pro]master ST1 Transceiver**. The ST1N is an excellent tool for advanced wireless flash photography using Nikon cameras and speedlights. Its various flash-mode functions include: I-TTL, M, DT, and it supports a maximum shutter sync speed of 1/8000S. It can also control up to three flash groups.

From the transmitter you can directly control the flash mode, output power, and focal length for each group. The ST1's remote distance can reach up to 100m while supporting 30 wireless channels and 1 auto channel.

### Here are some of the ST1's features:

- Dot matrix LCD display screen
- Supports wireless shutter release for camera
- Can be individually set to group A/B/C for flash focus
- Can be individually set to group A/B/C for flash exposure compensation and/or flash output
- Can be individually set to A/B/C flash mode: I-TTL/ manual flash
- Functions as a basic flash trigger (max sync speed is 1/250S) with a standard hot shoe (non nikon camera)
- Equipped with an AF focus assist beam (can be disabled)

- Please be sure to use the Transceiver's custom menu (Senior menu) to choose the specific flash model which is mounted on the hot shoe for best exposure results.

- Shutter Sync: first curtain sync, second curtain sync, and FP high-speed sync. Maximum sync speed is 1/8000s.
- Supports exposure compensation and flash value lock function
- Supports 30 wireless channels and 1 auto channel
- PC sync port
- Firmware can be upgraded through the USB interface

● **Please read this manual while also referring to your camera and speedlight's instruction manuals.**

### Included items:

The ST1 comes with the following accessories.

- Transceiver
- Mini Stand
- Manual

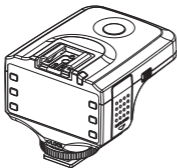

ST1N



Mini Stand



## Parts Identification

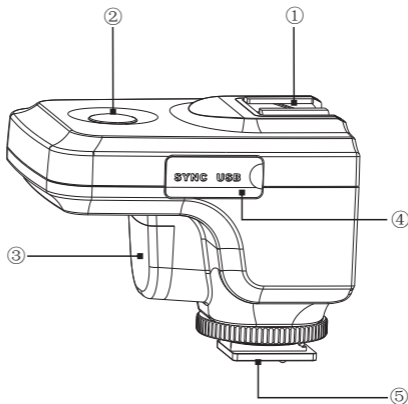

- ① Hot Shoe      ② Test Flash/Shutter Button  
③ AF Assist Beam Emitter      ④ PC sync port /  
⑤ Hot Foot                              USB Interface

## Parts Identification

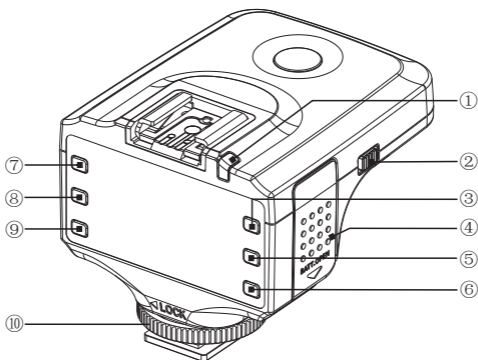

- ① Status Indicator    ② Power Switch    ③ Increase Button  
④ Battery Cover    ⑤ Decrease Button    ⑥ Confirm 'OK' Button  
⑦ Zoom Button    ⑧ Channel/Group Button    ⑨ Mode Button  
⑩ Locking Ring

## Transmitter Display

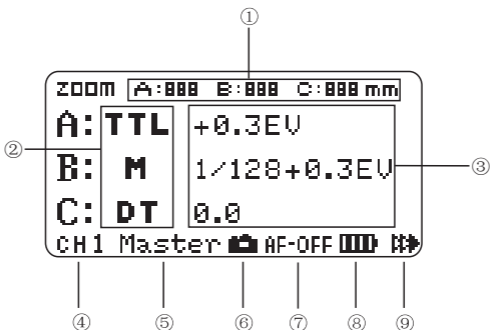

- ① Focal Length Area
- ② Group Function Mode Display Area
- ③ Exposure Compensation/  
Manual Output Display/Delay Time Area
- ④ Channel Icon   ⑤ Transceiver Mode
- ⑥ Camera Communication
- ⑦ AF Assist Beam Emitter State
- ⑧ Power Icon   ⑨ Sync Mode Display Area

## Receiver Display

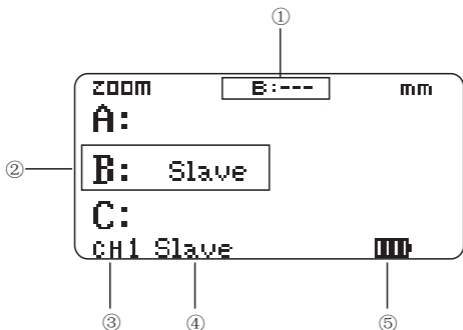

- ① Focal Length Area
- ② Group Area
- ③ Channel Icon
- ④ Transceiver mode
- ⑤ Power Icon

# Basic Operation

## Inserting the batteries

### 1 Open the cover.

Slide it down as shown by the arrow to open.

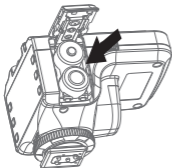

### 2 Installing the batteries.

Make sure the + and - battery contacts are properly oriented as shown in the battery compartment.

### 3 Closing the cover.

Close the battery compartment cover and slide it up as shown by the arrow.

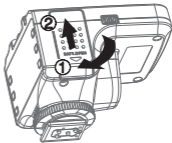

# Basic Operation

## Attaching to the camera



### 1 Preparing to attach the transceiver.

Loosen the locking ring by turning it in the direction of the arrow.

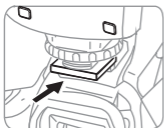

### 2 Attaching the transceiver.

Mount the transceiver into the camera's hot shoe by sliding it in all the way.

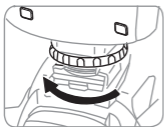

### 3 Securing the transceiver.

Turn the locking ring in the direction of the arrow to tighten.

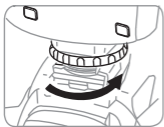

### 4 Detaching the transceiver.

Loosen the locking ring. Then remove the transceiver from the camera's hot shoe by sliding it out.

# Basic Operation

## Turning on the power

### 1 Turn on the power.

Turn the power switch to <ON>.

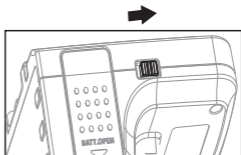

### 2 Turn off the power.

Turn the power switch to <OFF>.

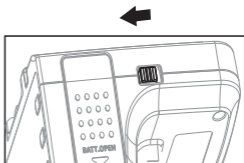

- In order to save power, the Transmitter will enter a sleep state after a specified time (this time can be adjusted as a custom setting). The LCD will not display. Press the shutter button halfway or press the test button to wake it up.
- As a Receiver it will not enter a sleep state.

# Custom Setting

You can customize the transmitter features to suit your shooting preferences with custom settings by using the Senior menu.

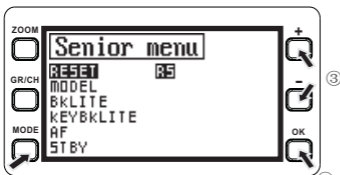







②

①

<b>RESET</b>	Reset custom setting
<b>RS</b>	RS: Reset
<b>MODEL</b>	Model
V760/200LS 331EX V500/600 OTHERS	Optimized for 200SL Optimized for 331EX Optimized for V500&V600 Optimized for Nikon flash and other manufacturers flashes
<b>BkLITE</b>	LCD backlight
OFF ON	OFF: Turn off ON: Turn on
<b>KEYBkLITE</b>	Button Backlight
OFF ON	OFF: Turn off ON: Turn on
<b>AF</b>	AF-assist illuminator
OFF ON	OFF: Turn off ON: Turn on
<b>STBY</b>	Standby function
15MIN 30MIN 45MIN OFF	15MIN: 15minutes 30MIN: 30minutes 45MIN: 45minutes OFF: Function canceled

LCDLITE	LCD contrast
5 4 3 2 1 0	5 represents the maximum contrast; 0 represents the minimum contrast
VER	Version of firmware
	Version

- Press the  button for approx. 2 seconds to display the custom setting menu.
- Press the  button to highlight a setting you wish to adjust.
  - Press the  button to access a particular setting.
  - Use the  and  buttons to adjust a setting.
- Press the  button to lock-in the new setting and return to the other custom options.

Finally, press the  button for approx. 2 seconds to exit the Custom settings menu.

\*Standby controls the length of time before the ST1 enters sleep mode.



# Transmitter operation

## Focal length setting

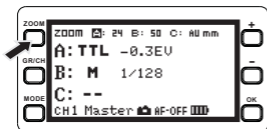

Press  button to highlight zoom A.

Continue pressing the button to highlight the B or C group and control the zoom setting for that group.

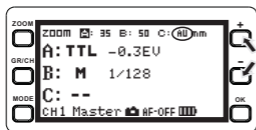

Press  button to manually increase the zoom setting.

Press  button to manually decrease the zoom setting.

Choose "AU" to automatically match the zoom setting of the lens.

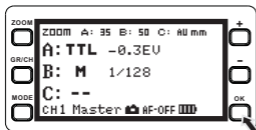

Press  button to confirm.

# Transmitter operation

## Group and mode settings

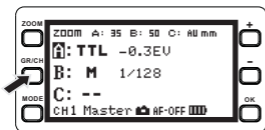

Press  button to highlight group A.

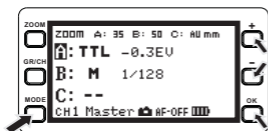



Press  button to choose a flash mode for the group. Press the  or  button to choose a compensation value for the group. Press the  button to confirm.

- TTL mode: The flash exposure compensation (FEC) value has a range of -3 to +3 EV.
- M manual mode: The FEC value has a range of 1/128 - 1/1 in 1/3 EV steps.
- DT mode: this mode allows the use of high speed sync. even when a flash does not have this feature. Set the flash to manual in this case. The camera must support high speed sync. for DT mode to properly function.

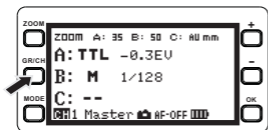

# Transmitter operation

## Transmitter channel setting

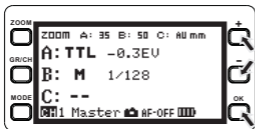

Press the  button for 2 sec. to highlight channel.



Press the  or  button to choose a channel.  
Press the  button to confirm.

- ① If another photographer is using a similar type of wireless flash system close by, your receivers may accidentally fire in sync with that photographer's transmitter. Use a different channel number to avoid this.
- ② Be sure to set the transmitter and receivers to the same channel.

# Receiver operation

## Group setting

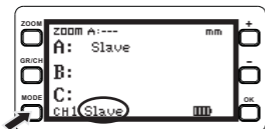

Press the  <sup>MODE</sup> button for 2 sec. to switch to receiver mode.

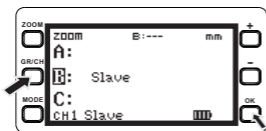

Press the  <sup>GR/CH</sup> button to highlight and select the desired group.

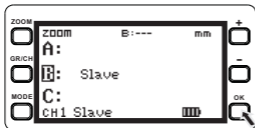

Press the  <sup>OK</sup> button to confirm.

# Receiver operation

## Receiver channel setting

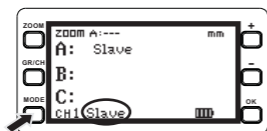

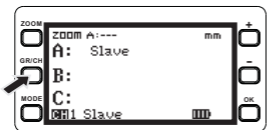

Press the  button for 2 sec. to choose receiver mode if you have not done so already..

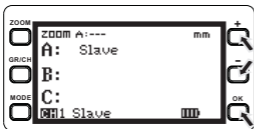

Press the  button for 2 sec. to highlight channel.



Press the  or  button to choose a channel.  
Press the  button to confirm and lock in the channel.

# Flash triggering

Before flash triggering, make sure the transmitter and receiver are on the same channel, and a flash is placed on each receiver's hotshoe.

## Testing

Turn on the transmitter, receivers, and flashes. Press the transmitter's test button. All groups which have been selected will flash at once. Receivers set to a different channel will not flash.

## Parameter control triggering mode

In this mode, the flash on the receiver must be set to TTL mode! The mode and output of the receiver flash(s) will be controlled from the transmitter. As you change the mode on the transmitter, each receiver in that group will display the newly chosen mode after one shot is fired.

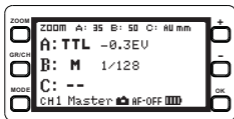

**Transmitter**

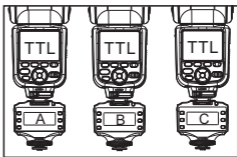

**Receiver**

\* Please Use **Receiver's** custom menu "Model" option to choose the speedlight model which is mounted on hot shoe.

# Flash triggering

## Non-parameter control triggering mode

Set the speedlight on the receiver to Manual or RPT mode. In this case the speedlight will work according to its own mode and settings. The transmitter will not control the flash mode or exposure compensation. The transmitter will, however, fire the flash.

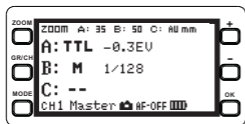

**Transmitter**

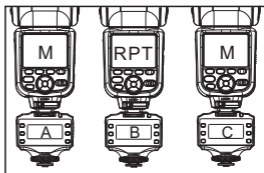

**Receiver**

# Advanced Applications

## Shutter release function

The ST1 can also be used as a wireless, remote shutter release for your camera.

1. Install a transceiver on the camera's hot shoe, and use a shutter connecting cable to connect the transceiver's PC sync port to the camera.

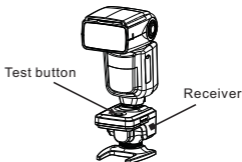
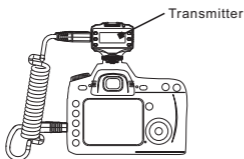

2. Press the test button of another ST1 transceiver to focus and shoot. If a speedlight is installed on the transceiver it will fire in sync.

● Shutter release cables are sold separately.



# Advanced Applications

## Firmware Updates

The ST1 has a USB service port located next to its PC sync port.

While the ST1 is designed to work with cameras presently available in the market, it may require firmware updates as new cameras and speedlights are released, or as cameras are updated with new firmware. Refer to [www.promaster.com](http://www.promaster.com) for the most recent firmware.

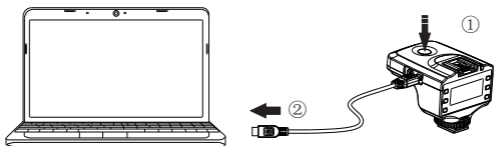

### To update the ST1's firmware:

- ① **Turn off the power.** Hold down the test button.
- ② Connect to a computer using a USB-MINI cable.
- ③ Use the PC terminal software to update the firmware.

- Before updating the firmware, remember to turn off the power.
- USB-MINI cable sold separately.

# Troubleshooting Guide

---

## **Power does not turn on.**

---

- Replace the batteries if they are low or out of power.
- Check that the batteries are installed in the correct orientation.

## **The slave speedlight does not fire.**

---

- Make sure all transceivers are powered on and the speedlight is on and in a ready state.
- Check that the transmitter and receiver are set to the same channels and groups.
- Check the electrical contacts of the transceiver and camera and all speedlights. Reposition them or clean the contacts if necessary.

# Troubleshooting Guide

---

## **The picture is underexposed or overexposed.**

---

- Be cautious of highly reflective objects (glass window, etc.) which can trick the camera's exposure meter.
- If the subject is very dark or very bright, you may need to use flash exposure compensation.
- When high-speed sync is set, the effective flash range is shorter. Position the slave unit closer to the subject.
- When using autoflash shooting with three firing groups A, B and C, do not fire with group C pointed toward the main subject.
- Overexposure may occur when TTL and manual flashes are used at the same time. In this case a manual flash makes a suitable backlight and should be adjusted properly.
- Be sure the proper flash model is selected in the Custom menu (Senior menu).

## **The picture is blurred.**

---

- When the camera's shooting mode is set to <AV> and the scene is dark, slow sync may be enabled automatically (the shutter speed becomes slower). Use a tripod, or set the shooting mode to <P> or fully automatic mode.

# Specifications

System type: Digital FSK 2.4GHz wireless controller

Range: 100M

Channels: 30 channels and 1 auto channel

Flash modes: I-TTL, Manual, DT

Sync modes: front-curtain sync, rear-curtain sync,  
FP sync

Groups: 3 Groups(A/B/C)

Shutter: Supports camera control camera single  
shooting

Maximum sync speed: 1/8000S

AF assist beam emitter: supported

Speedlight auto zoom: supported

USB firmware upgrade: supported

Battery type: AA×2

Stand-by time: 120h

Dimensions: 77.8mm(L)×65mm(W)×62mm(H)

Weight: 98g (without batteries)

● Design and specifications subject to change without notice.



# *One Year Unconditional Warranty*

---

If for any reason, this ProMaster product fails within ONE YEAR of the date of purchase, return this product to your ProMaster dealer and it will be exchanged for you at no charge. ProMaster products are guaranteed for ONE FULL YEAR against defects in workmanship and materials. If at any time after one year, your ProMaster product fails under normal use, we invite you to return it to ProMaster for evaluation.

WWW.PROMASTER.COM | FAIRFIELD CT 06825

**FOR  
NIKON**

Made in China  
**Code 4660**

